









# Clio

## Frente ducha Corredera

1 puerta + 1 fijo



-  Cristal templado de 5 mm.
-  Altura 190 cm.
-  Cierre magnético.
-  Perfilera aluminio 1.1.
-  Incluye 2 perfiles de compensación de 15 mm.
-  Fácil desmontaje de las puertas.
-  Reversible.
-  Embalaje de alta seguridad.
-  Certificado de conformidad europea.

2 ruedas dobles superiores por puerta, para mayor suavidad de apertura y cierre.

2 ruedas sencillas inferiores, retráctiles, por puerta para mayor suavidad.











### Opciones

-  Transparente o serigrafía al ácido.
-  Perfil de supercompensación 50 mm opcional.



Desmontaje rodamientos.





	100 cm	110 cm	120 cm	130 cm	140 cm	150 cm	160 cm	170 cm
Transparente	REF. B-187	REF. B-188	REF. B-189	REF. B-190	REF. B-191	REF. B-192	REF. B-193	REF. B-194
Serigrafía	B-17	B-18	B-19	B-20	B-21	B-22	B-23	B-24
Bultos	1 	1 	1 	1 	1 	1 	1 	1 
ancho de paso	41 (aprox.)	46 (aprox.)	51 (aprox.)	56 (aprox.)	61 (aprox.)	66 (aprox.)	71 (aprox.)	76 (aprox.)
altura	190	190	190	190	190	190	190	190
adaptability	adaptable de 97 a 100	adaptable de 107 a 110	adaptable de 117 a 120	adaptable de 127 a 130	adaptable de 137 a 140	adaptable de 147 a 150	adaptable de 157 a 160	adaptable de 167 a 170
SC profiles	con dos perfiles SC máx 107	con dos perfiles SC máx 117	con dos perfiles SC máx 127	con dos perfiles SC máx 137	con dos perfiles SC máx 147	con dos perfiles SC máx 157	con dos perfiles SC máx 167	con dos perfiles SC máx 177

# Clio

**Rectangular** Corredera  
acceso angular

**FRENTE**  
1 puerta + 1 fijo | **LATERAL**  
1 puerta + 1 fijo





-  Cristal templado de 5 mm.
-  Altura 190 cm.
-  Cierre magnético.
-  Perfilería aluminio 1.1.
-  Incluye 2 perfiles de compensación de 15 mm.
-  Fácil desmontaje de las puertas.
-  Reversible.
-  Embalaje de alta seguridad.
-  Certificado de conformidad europea.



2 ruedas dobles superiores por puerta, para mayor suavidad de apertura y cierre.

2 ruedas sencillas inferiores, retráctiles, por puerta para mayor suavidad.

### Opciones

-  Transparente o serigrafía al ácido.
-  Perfil de supercompensación 50 mm opcional. Ver página 127.





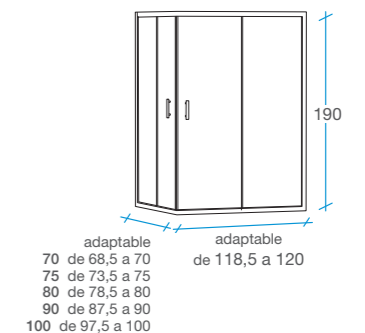
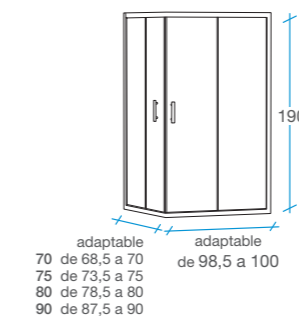
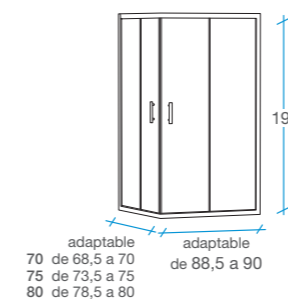





	90 cm			100 cm				120 cm				
	Frente 90 + Lateral (fijo+puerta)			Frente 100 + Lateral (fijo+puerta)				Frente 120 + Lateral (fijo+puerta)				
Lateral	70	75	80	70	75	80	90	70	75	80	90	100
	REF.	REF.	REF.	REF.	REF.	REF.	REF.	REF.	REF.	REF.	REF.	REF.
Transparente	B-209 B-203	B-209 B-204	B-209 B-205	B-210 B-203	B-210 B-204	B-210 B-205	B-210 B-209	B-211 B-203	B-211 B-204	B-211 B-205	B-211 B-209	B-211 B-210
Serigrafía	B-206 B-200	B-206 B-201	B-206 B-202	B-207 B-200	B-207 B-201	B-207 B-202	B-207 B-206	B-208 B-200	B-208 B-201	B-208 B-202	B-208 B-206	B-208 B-207
Bultos	2 			2 				2 				



# Clio

**Rectangular** Corredera  
acceso frontal



**FRENTE**  
1 puerta + 1 fijo | **LATERAL**  
1 fijo









-  Cristal templado de 5 mm.
-  Altura 190 cm.
-  Cierre magnético.
-  Perfilera aluminio 1.1.
-  Incluye 2 perfiles de compensación de 15 mm.
-  Fácil desmontaje de las puertas.
-  Reversible.
-  Embalaje de alta seguridad.
-  Certificado de conformidad europea.



2 ruedas dobles superiores por puerta, para mayor suavidad de apertura y cierre.  
2 ruedas sencillas inferiores, retráctiles, por puerta para mayor suavidad.

### Opciones

-  Transparente o serigrafía al ácido.
-  Perfil de supercompensación 50 mm opcional. Ver página 127.

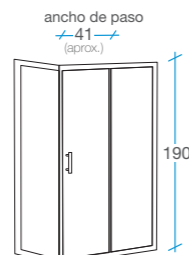
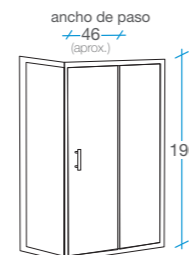
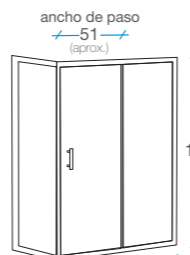
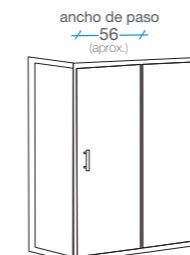
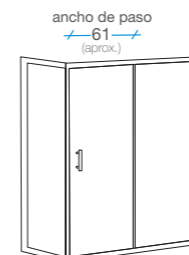
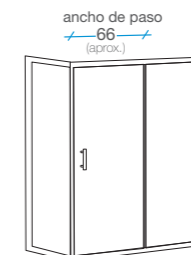
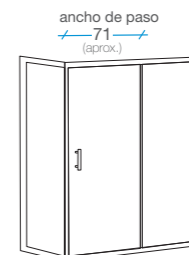
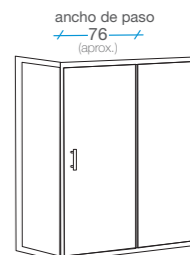
	100 cm		110 cm		120 cm		130 cm		140 cm		150 cm		160 cm		170 cm	
	Frente 100 + Lateral fijo		Frente 110 + Lateral fijo		Frente 120 + Lateral fijo		Frente 130 + Lateral fijo		Frente 140 + Lateral fijo		Frente 150 + Lateral fijo		Frente 160 + Lateral fijo		Frente 170 + Lateral fijo	
Lateral	70	80	70	80	70	80	70	80	70	80	70	80	70	80	70	80
Transparente	REF. B-187 B-195	REF. B-187 B-196	REF. B-188 B-195	REF. B-188 B-196	REF. B-189 B-195	REF. B-189 B-196	REF. B-190 B-195	REF. B-190 B-196	REF. B-191 B-195	REF. B-191 B-196	REF. B-192 B-195	REF. B-192 B-196	REF. B-193 B-195	REF. B-193 B-196	REF. B-194 B-195	REF. B-194 B-196
Serigrafía	B-17 B-24	B-17 B-25	B-18 B-24	B-18 B-25	B-19 B-24	B-19 B-25	B-20 B-24	B-20 B-25	B-21 B-24	B-21 B-25	B-22 B-24	B-22 B-25	B-23 B-24	B-23 B-25	B-52 B-24	B-52 B-25
Bultos	2 		2 		2 		2 		2 		2 		2 		2 	
	ancho de paso 41 (aprox.) 		ancho de paso 46 (aprox.) 		ancho de paso 51 (aprox.) 		ancho de paso 56 (aprox.) 		ancho de paso 61 (aprox.) 		ancho de paso 66 (aprox.) 		ancho de paso 71 (aprox.) 		ancho de paso 76 (aprox.) 	
	adaptable 70 de 68 a 70 adaptable 80 de 78 a 80 adaptable de 97 a 100		adaptable 70 de 68 a 70 adaptable 80 de 78 a 80 adaptable de 107 a 110		adaptable 70 de 68 a 70 adaptable 80 de 78 a 80 adaptable de 117 a 120		adaptable 70 de 68 a 70 adaptable 80 de 78 a 80 adaptable de 127 a 130		adaptable 70 de 68 a 70 adaptable 80 de 78 a 80 adaptable de 137 a 140		adaptable 70 de 68 a 70 adaptable 80 de 78 a 80 adaptable de 147 a 150		adaptable 70 de 68 a 70 adaptable 80 de 78 a 80 adaptable de 157 a 160		adaptable 70 de 68 a 70 adaptable 80 de 78 a 80 adaptable de 167 a 170	

# Clio

**Cuadrada** Corredera  
acceso angular



**FRENTE** 1 puerta + 1 fijo | **LATERAL** 1 puerta + 1 fijo

-  Cristal templado de 5 mm.
-  Altura 190 cm.
-  Cierre magnético.
-  Perfilería aluminio 1.1.
-  Incluye 2 perfiles de compensación de 15 mm.
-  Fácil desmontaje de las puertas.
-  Reversible.
-  Embalaje de alta seguridad.
-  Certificado de conformidad europea.



2 ruedas dobles superiores por puerta, para mayor suavidad de apertura y cierre.

2 ruedas sencillas inferiores, retráctiles, por puerta para mayor suavidad.



## Opciones

-  Transparente o serigrafía al ácido.
-  Perfil de supercompensación 50 mm opcional. Ver página 127.



	80x80 cm	90x90 cm	100x100 cm
Transparente	REF. 2x B-205	REF. 2x B-209	REF. 2x B-210
Serigrafía	2x B-202	2x B-206	2x B-207
Bultos	2 	2 	2 

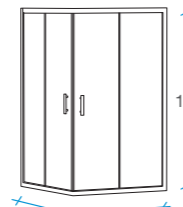









  

		
adaptable de 78,5 a 80	adaptable de 88,5 a 90	adaptable de 98,5 a 100

# Clio

## 1/4 Círculo Corredera

1 puerta + 1 fijo | 1 puerta + 1 fijo

-  Cristal templado de 5 mm.
  -  Altura 190 cm.
  -  Cierre magnético.
  -  Perfilería aluminio 1.1.
  -  Incluye 2 perfiles de compensación de 15 mm.
  -  Fácil desmontaje de las puertas.
  -  Reversible.
  -  Embalaje de alta seguridad.
  -  Certificado de conformidad europea.
- Opciones**
-  Transparente o serigrafía al ácido.
  -  Perfil de supercompensación 50 mm opcional. Ver página 127.

