









Clio

Frente ducha Corredera

1 puerta + 1 fijo



-  Cristal templado de 5 mm.
-  Altura 190 cm.
-  Cierre magnético.
-  Perfilera aluminio 1.1.
-  Incluye perfiles de compensación de 15 mm.
-  Fácil desmontaje de las puertas.
-  Reversible.
-  Embalaje de alta seguridad.
-  Certificado de conformidad Europea.

2 ruedas dobles superiores por puerta, para mayor suavidad de apertura y cierre.

2 ruedas sencillas inferiores, retráctiles, por puerta para mayor suavidad.











Opciones

-  Transparente o serigrafía al ácido.
-  Perfil de supercompensación 50 mm opcional.











Desmontaje rodamientos.

	100 cm	110 cm	120 cm	130 cm	140 cm	150 cm	160 cm	170 cm
Transparente	REF. B-187	REF. B-188	REF. B-189	REF. B-190	REF. B-191	REF. B-192	REF. B-193	REF. B-194
Serigrafía	B-17	B-18	B-19	B-20	B-21	B-22	B-23	B-24
Bultos	1 	1 	1 	1 	1 	1 	1 	1 
ancho de paso	41 (aprox.)	46 (aprox.)	51 (aprox.)	56 (aprox.)	61 (aprox.)	66 (aprox.)	71 (aprox.)	76 (aprox.)
altura	190	190	190	190	190	190	190	190
adaptabilidad	adaptable de 97 a 100	adaptable de 107 a 110	adaptable de 117 a 120	adaptable de 127 a 130	adaptable de 137 a 140	adaptable de 147 a 150	adaptable de 157 a 160	adaptable de 167 a 170
perfilera	con dos perfiles SC máx. 107	con dos perfiles SC máx. 117	con dos perfiles SC máx. 127	con dos perfiles SC máx. 137	con dos perfiles SC máx. 147	con dos perfiles SC máx. 157	con dos perfiles SC máx. 167	con dos perfiles SC máx. 177

Clio

Rectangular Corredera
acceso frontal



FRENTE
1 puerta + 1 fijo | **LATERAL**
1 fijo









-  Cristal templado de 5 mm.
-  Altura 190 cm.
-  Cierre magnético.
-  Perfilera aluminio 1.1.
-  Incluye perfiles de compensación de 15 mm.
-  Fácil desmontaje de las puertas.
-  Reversible.
-  Embalaje de alta seguridad.
-  Certificado de conformidad Europea.



2 ruedas dobles superiores por puerta, para mayor suavidad de apertura y cierre.
2 ruedas sencillas inferiores, retráctiles, por puerta para mayor suavidad.

Opciones



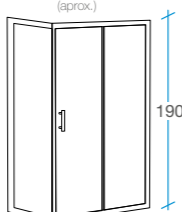
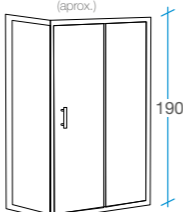
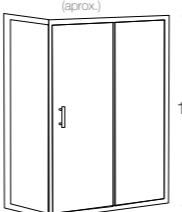
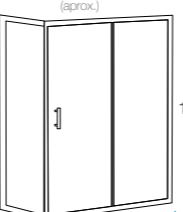
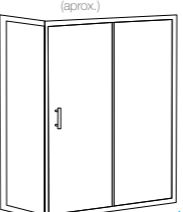
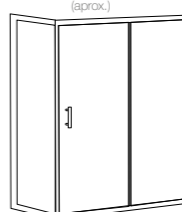
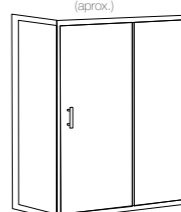
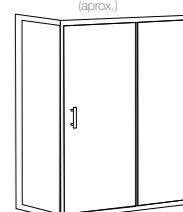





-  Transparente o serigrafía al ácido.
-  Perfil de supercompensación 50 mm opcional. Ver página 119.

	100 cm		110 cm		120 cm		130 cm		140 cm		150 cm		160 cm		170 cm	
	Frente 100 + Lateral fijo		Frente 110 + Lateral fijo		Frente 120 + Lateral fijo		Frente 130 + Lateral fijo		Frente 140 + Lateral fijo		Frente 150 + Lateral fijo		Frente 160 + Lateral fijo		Frente 170 + Lateral fijo	
Lateral	70	80	70	80	70	80	70	80	70	80	70	80	70	80	70	80
Transparente	B-187 B-195	B-187 B-196	B-188 B-195	B-188 B-196	B-189 B-195	B-189 B-196	B-190 B-195	B-190 B-196	B-191 B-195	B-191 B-196	B-192 B-195	B-192 B-196	B-193 B-195	B-193 B-196	B-194 B-195	B-194 B-196
Serigrafía	B-17 B-24	B-17 B-25	B-18 B-24	B-18 B-25	B-19 B-24	B-19 B-25	B-20 B-24	B-20 B-25	B-21 B-24	B-21 B-25	B-22 B-24	B-22 B-25	B-23 B-24	B-23 B-25	B-52 B-24	B-52 B-25
Bultos	2 		2 		2 		2 		2 		2 		2 		2 	
	ancho de paso 41 (aprox.)		ancho de paso 46 (aprox.)		ancho de paso 51 (aprox.)		ancho de paso 56 (aprox.)		ancho de paso 61 (aprox.)		ancho de paso 66 (aprox.)		ancho de paso 71 (aprox.)		ancho de paso 76 (aprox.)	
																
	adaptable 70 de 68 a 70 80 de 78 a 80		adaptable 70 de 68 a 70 80 de 78 a 80		adaptable 70 de 68 a 70 80 de 78 a 80		adaptable 70 de 68 a 70 80 de 78 a 80		adaptable 70 de 68 a 70 80 de 78 a 80		adaptable 70 de 68 a 70 80 de 78 a 80		adaptable 70 de 68 a 70 80 de 78 a 80		adaptable 70 de 68 a 70 80 de 78 a 80	
	adaptable de 97 a 100		adaptable de 107 a 110		adaptable de 117 a 120		adaptable de 127 a 130		adaptable de 137 a 140		adaptable de 147 a 150		adaptable de 157 a 160		adaptable de 167 a 170	

Clio

Rectangular Corredera
acceso angular



FRENTE
1 puerta + 1 fijo | **LATERAL**
1 puerta + 1 fijo

-  Cristal templado de 5 mm.
-  Altura 190 cm.
-  Cierre magnético.
-  Perfilería aluminio 1.1.
-  Incluye perfiles de compensación de 15 mm.
-  Fácil desmontaje de las puertas.
-  Reversible.
-  Embalaje de alta seguridad.
-  Certificado de conformidad Europea.

2 ruedas dobles superiores por puerta, para mayor suavidad de apertura y cierre.



2 ruedas sencillas inferiores, retráctiles, por puerta para mayor suavidad.

Opciones

-  Transparente o serigrafía al ácido.
-  Perfil de supercompensación 50 mm opcional. Ver página 119.



80

	Frente 80 + Lateral (fijo+puerta)		
Lateral	70 REF. B-205 B-203	75 REF. B-205 B-204	80 REF. B-205 B-205
Transparente	B-205 B-203	B-205 B-204	B-205 B-205
Serigrafía	B-202 B-200	B-202 B-201	B-202 B-202
Bultos	2 	2 	2 

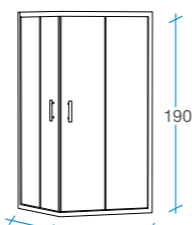

adaptable 70 de 68,5 a 70
75 de 73,5 a 75
80 de 78,5 a 80

adaptable de 78,5 a 80

90 cm

	Frente 90 + Lateral (fijo+puerta)			
Lateral	70 REF. B-209 B-203	75 REF. B-209 B-204	80 REF. B-209 B-205	90 REF. B-209 B-209
Transparente	B-209 B-203	B-209 B-204	B-209 B-205	B-209 B-209
Serigrafía	B-206 B-200	B-206 B-201	B-206 B-202	B-206 B-206
Bultos	2 			

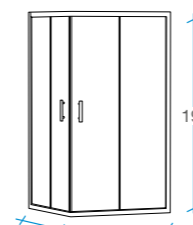

adaptable 70 de 68,5 a 70
75 de 73,5 a 75
80 de 78,5 a 80
90 de 87,5 a 90

adaptable de 88,5 a 90

100 cm

	Frente 100 + Lateral (fijo+puerta)				
Lateral	70 REF. B-210 B-203	75 REF. B-210 B-204	80 REF. B-210 B-205	90 REF. B-210 B-209	100 REF. B-210 B-210
Transparente	B-210 B-203	B-210 B-204	B-210 B-205	B-210 B-209	B-210 B-210
Serigrafía	B-207 B-200	B-207 B-201	B-207 B-202	B-207 B-206	B-207 B-207
Bultos	2 				

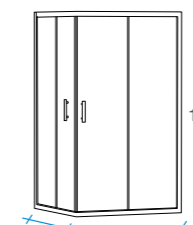

adaptable 70 de 68,5 a 70
75 de 73,5 a 75
80 de 78,5 a 80
90 de 87,5 a 90
100 de 97,5 a 100

adaptable de 98,5 a 100

120 cm

	Frente 120 + Lateral (fijo+puerta)				
Lateral	70 REF. B-211 B-203	75 REF. B-211 B-204	80 REF. B-211 B-205	90 REF. B-211 B-209	100 REF. B-211 B-210
Transparente	B-211 B-203	B-211 B-204	B-211 B-205	B-211 B-209	B-211 B-210
Serigrafía	B-208 B-200	B-208 B-201	B-208 B-202	B-208 B-206	B-208 B-207
Bultos	2 				



adaptable 70 de 68,5 a 70
75 de 73,5 a 75
80 de 78,5 a 80
90 de 87,5 a 90
100 de 97,5 a 100









adaptable de 118,5 a 120



Clio



1/4 Círculo Corredera

1 puerta + 1 fijo | 1 puerta + 1 fijo

-  Cristal templado de 5 mm.
-  Altura 190 cm.
-  Cierre magnético.
-  Perfilera aluminio 1.1.
-  Incluye perfiles de compensación de 15 mm.
-  Fácil desmontaje de las puertas.
-  Reversible.
-  Embalaje de alta seguridad.
-  Certificado de conformidad Europea.

2 ruedas dobles superiores por puerta, para mayor suavidad de apertura y cierre.
2 ruedas sencillas inferiores, retráctiles, por puerta para mayor suavidad.

Opciones

-  Transparente o serigrafía al ácido.
-  Perfil de supercompensación 50 mm opcional. Ver página 119.

