

Manhattan Negro

Frente ducha Corredera

1 puerta + 1 fijo



Tratamiento antical Fast Clean.



Sin perfilera inferior.



Embalaje de alta seguridad.



Cristal templado de 8 mm transparente.



Incluye perfil receptor autoadhesivo.



Certificado de conformidad Europea.



Altura 200 cm.

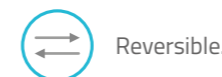

Reversible.

Brazo de sujeción adaptable.

Sistema de sujeción opcional. Permite la instalación apoyándose únicamente en uno o dos laterales.



Manhattan Negro

Frente ducha Corredera

2 puertas + 2 fijos

-  Acceso central.
-  Tratamiento antical Fast Clean.
-  Cristal templado de 8 mm transparente.
-  Altura 200 cm.
-  Cierre magnético.
-  Sin perfilera inferior.
-  Embalaje de alta seguridad.
-  Certificado de conformidad Europea.

Brazo de sujeción adaptable.

Sistema de sujeción opcional.

Permite la instalación apoyándose en los laterales.

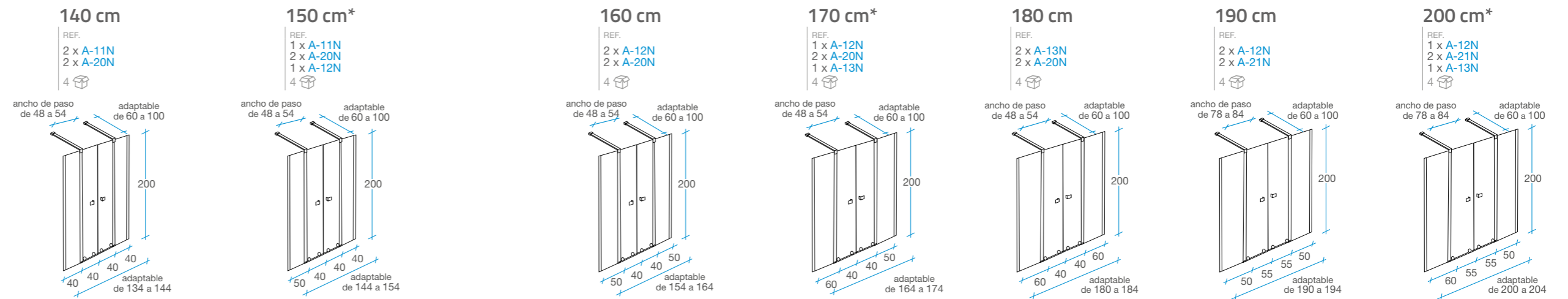

* Fijos de distinta medida. Puertas de acceso desplazadas ligeramente del centro.

Rectangular Corredera

acceso frontal

FRENTE
1 puerta + 1 fijo

LATERAL
1 fijo

Manhattan Negro



Manhattan Negro

Rectangular Corredera acceso frontal

FRENTE 1 puerta + 1 fijo | LATERAL 1 fijo

- Tratamiento antical Fast Clean.
- Sin perifería inferior.
- Embalaje de alta seguridad.
- Cristal templado de 8 mm transparente.
- Reversible.
- Incluye perfil receptor autoadhesivo.
- Altura 200 cm.
- Certificado de conformidad Europea.
- Brazo de sujeción adaptable.

Sistema de sujeción opcional. Permite la instalación apoyándose únicamente en uno o dos laterales.



100 cm

Frente 100 + Lateral fijo	
70 REF.	80 REF.
A-12N	A-12N
A-22N	A-22N
A-14N	A-15N
P-20N	P-20N

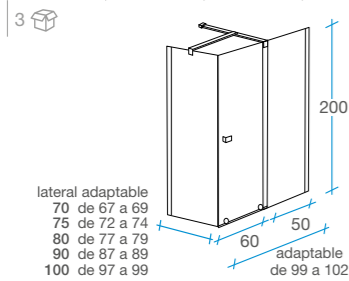

110 cm

Frente 110 + Lateral fijo	
70 REF.	80 REF.
A-13N	A-13N
A-22N	A-22N
A-14N	A-15N
P-20N	P-20N

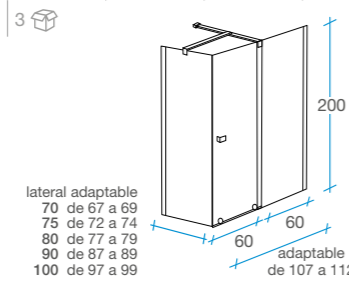

115 cm

Frente 115 + Lateral fijo	
70 REF.	80 REF.
A-13N	A-13N
A-25N	A-25N
A-14N	A-15N
P-20N	P-20N

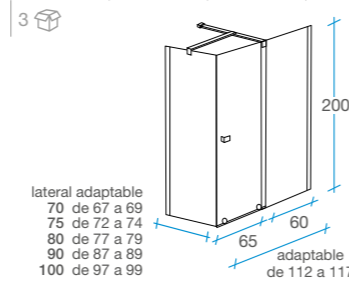

120 cm

Frente 120 + Lateral fijo	
70 REF.	80 REF.
A-14N	A-14N
A-22N	A-22N
A-14N	A-15N
P-20N	P-20N

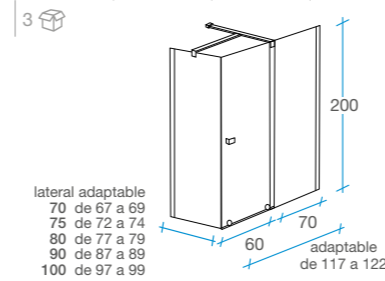

125 cm

Frente 125 + Lateral fijo	
70 REF.	80 REF.
A-14N	A-14N
A-25N	A-25N
A-14N	A-15N
P-20N	P-20N

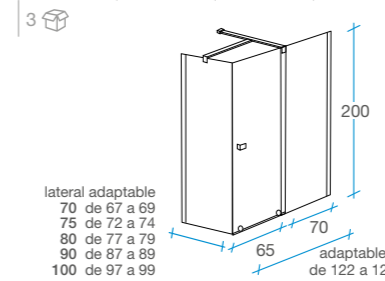

130 cm

Frente 130 + Lateral fijo	
70 REF.	80 REF.
A-14N	A-14N
A-23N	A-23N
A-14N	A-15N
P-20N	P-20N

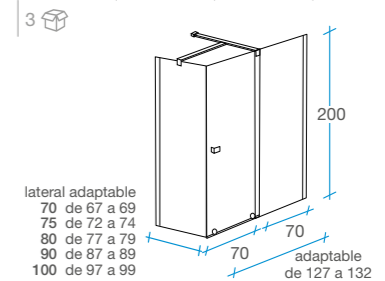

135 cm

Frente 135 + Lateral fijo	
70 REF.	80 REF.
A-14N	A-14N
A-26N	A-26N
A-14N	A-15N
P-20N	P-20N

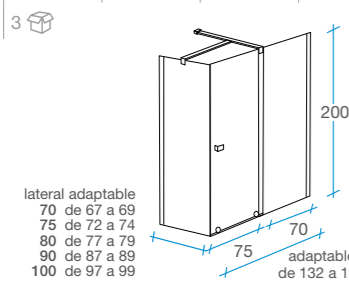

140 cm

Frente 140 + Lateral fijo	
70 REF.	80 REF.
A-15N	A-15N
A-23N	A-23N
A-14N	A-15N
P-20N	P-20N

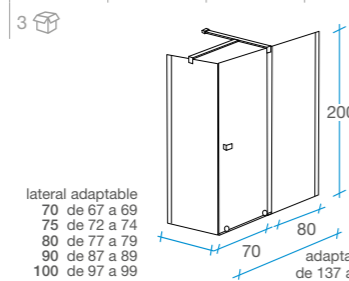

145 cm

Frente 145 + Lateral fijo	
70 REF.	80 REF.
A-15N	A-15N
A-26N	A-26N
A-14N	A-15N
P-20N	P-20N

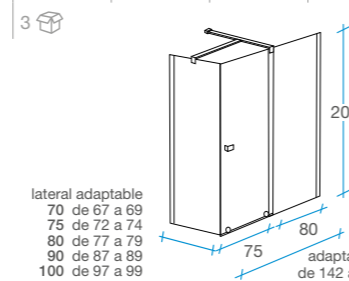

150 cm

Frente 150 + Lateral fijo	
70 REF.	80 REF.
A-15N	A-15N
A-24N	A-24N
A-14N	A-15N
P-20N	P-20N

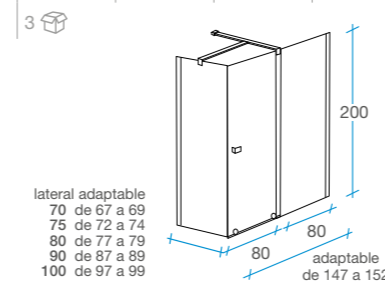

155 cm

Frente 155 + Lateral fijo	
70 REF.	80 REF.
A-16N	A-16N
A-26N	A-26N
A-14N	A-15N
P-20N	P-20N

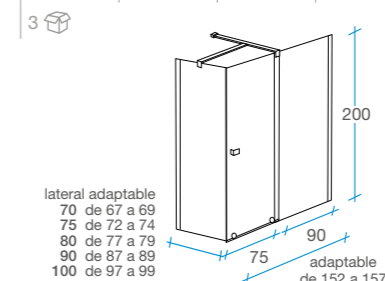

160 cm

Frente 160 + Lateral fijo	
70 REF.	80 REF.
A-16N	A-16N
A-24N	A-24N
A-14N	A-15N
P-20N	P-20N

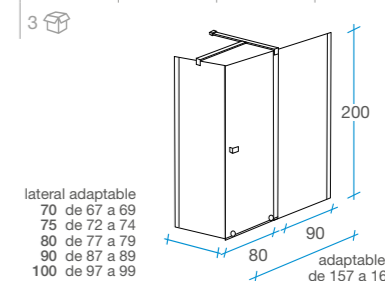

165 cm

Frente 165 + Lateral fijo	
70 REF.	80 REF.
A-17N	A-17N
A-26N	A-26N
A-14N	A-15N
P-20N	P-20N

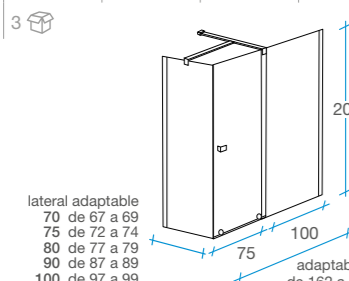

170 cm

Frente 170 + Lateral fijo	
70 REF.	80 REF.
A-17N	A-17N
A-24N	A-24N
A-14N	A-15N
P-20N	P-20N

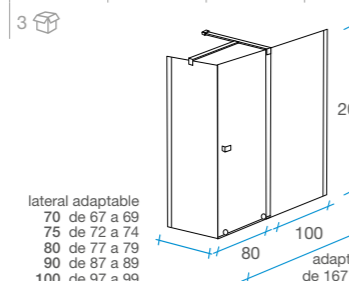

175 cm

Frente 175 + Lateral fijo	
70 REF.	80 REF.
A-18N	A-18N
A-26N	A-26N
A-14N	A-15N
P-20N	P-20N

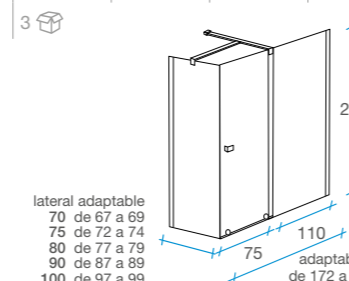

180 cm

Frente 180 + Lateral fijo	
70 REF.	80 REF.
A-18N	A-18N
A-24N	A-24N
A-14N	A-15N
P-20N	P-20N

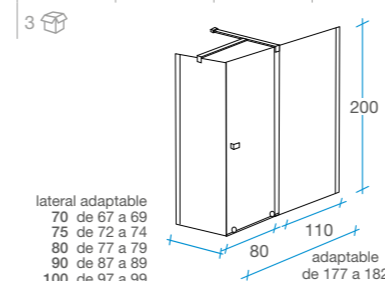

185 cm

Frente 185 + Lateral fijo	
70 REF.	80 REF.
A-19N	A-19N
A-26N	A-26N
A-14N	A-15N
P-20N	P-20N

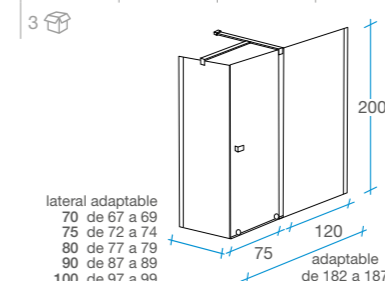

190 cm

Frente 190 + Lateral fijo	
70 REF.	80 REF.
A-19N	A-19N
A-24N	A-24N
A-14N	A-15N
P-20N	P-20N

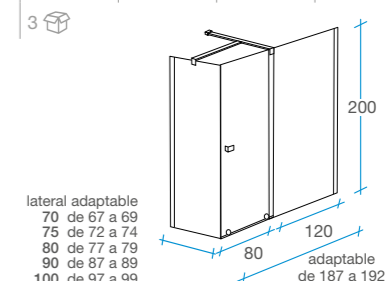

Manhattan Negro

Walk in

1 fijo o 2 fijos

-  Tratamiento antical Fast Clean.
-  Cristal templado de 8 mm transparente.
-  Altura 200 cm.

-  Sin perfilera inferior.
-  Reversible.
-  Embalaje de alta seguridad.

-  Certificado de conformidad Europea.
- Brazo de sujeción adaptable.

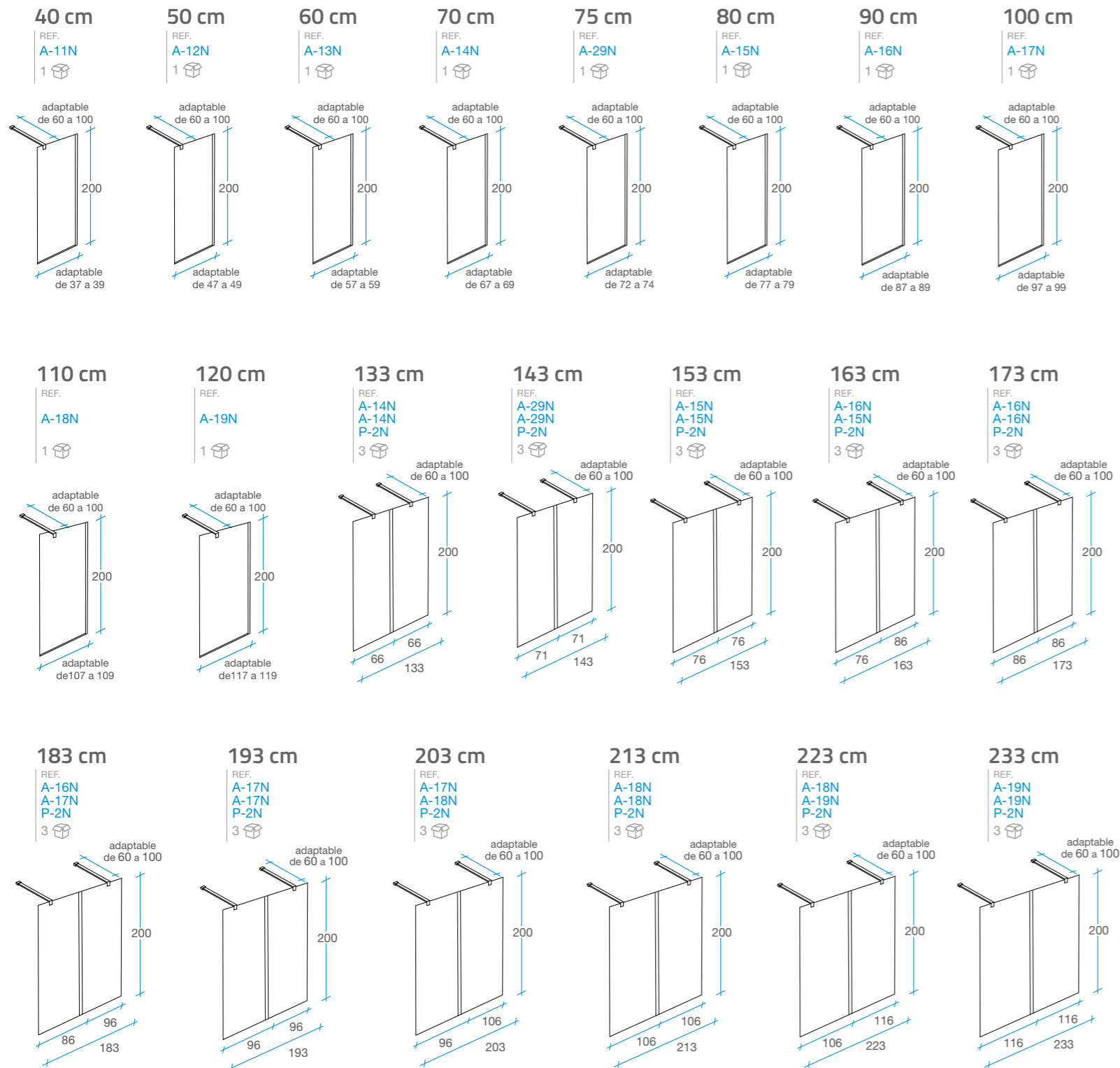

Manhattan Negro

Walk in

FRENTE 1 fijo | LATERAL 1 fijo

Sistema de sujeción opcional. Permite la instalación apoyándose únicamente en los laterales.



80 cm

Frente 80 + Lateral fijo

40 REF. A-15N A-11N P-20N	50 REF. A-15N A-12N P-20N	60 REF. A-15N A-13N P-20N	70 REF. A-15N A-14N P-20N	75 REF. A-15N A-29N P-20N	80 REF. A-15N A-15N P-20N	90 REF. A-15N A-16N P-20N	100 REF. A-15N A-17N P-20N
---------------------------	---------------------------	---------------------------	---------------------------	---------------------------	---------------------------	---------------------------	----------------------------

2

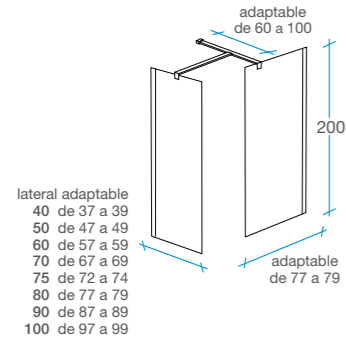

90 cm

Frente 90 + Lateral fijo

40 REF. A-16N A-11N P-20N	50 REF. A-16N A-12N P-20N	60 REF. A-16N A-13N P-20N	70 REF. A-16N A-14N P-20N	75 REF. A-16N A-29N P-20N	80 REF. A-16N A-15N P-20N	90 REF. A-16N A-16N P-20N	100 REF. A-16N A-17N P-20N
---------------------------	---------------------------	---------------------------	---------------------------	---------------------------	---------------------------	---------------------------	----------------------------

2

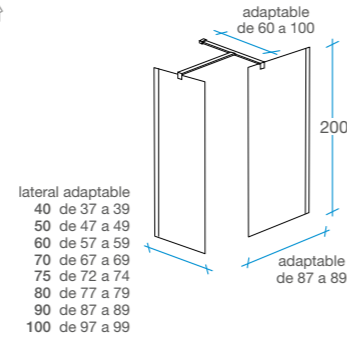

100 cm

Frente 100 + Lateral fijo

40 REF. A-17N A-11N P-20N	50 REF. A-17N A-12N P-20N	60 REF. A-17N A-13N P-20N	70 REF. A-17N A-14N P-20N	75 REF. A-17N A-29N P-20N	80 REF. A-17N A-15N P-20N	90 REF. A-17N A-16N P-20N	100 REF. A-17N A-17N P-20N
---------------------------	---------------------------	---------------------------	---------------------------	---------------------------	---------------------------	---------------------------	----------------------------

32

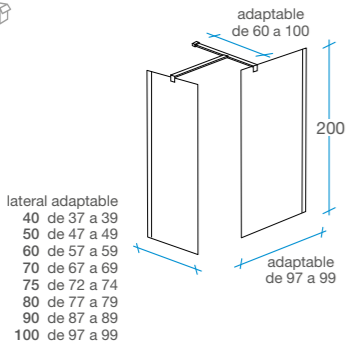

110 cm

Frente 110 + Lateral fijo

40 REF. A-18N A-11N P-20N	50 REF. A-18N A-12N P-20N	60 REF. A-18N A-13N P-20N	70 REF. A-18N A-14N P-20N	75 REF. A-18N A-29N P-20N	80 REF. A-18N A-15N P-20N	90 REF. A-18N A-16N P-20N	100 REF. A-18N A-17N P-20N
---------------------------	---------------------------	---------------------------	---------------------------	---------------------------	---------------------------	---------------------------	----------------------------

2

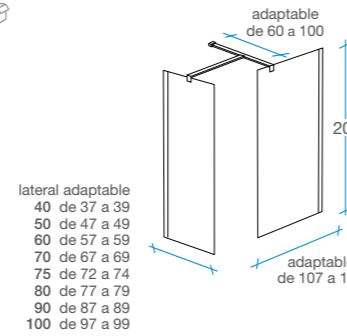

120 cm

Frente 120 + Lateral fijo

40 REF. A-19N A-11N P-20N	50 REF. A-19N A-12N P-20N	60 REF. A-19N A-13N P-20N	70 REF. A-19N A-14N P-20N	75 REF. A-19N A-29N P-20N	80 REF. A-19N A-15N P-20N	90 REF. A-19N A-16N P-20N	100 REF. A-19N A-17N P-20N
---------------------------	---------------------------	---------------------------	---------------------------	---------------------------	---------------------------	---------------------------	----------------------------

2

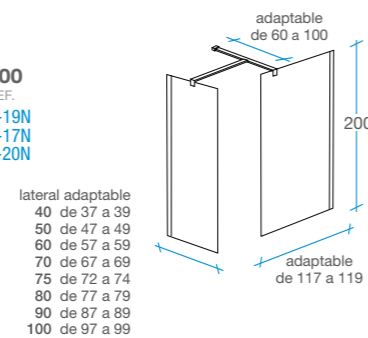

Tratamiento antical Fast Clean.

Cristal templado de 8 mm transparente.

Altura 200 cm.

Sin perfilera inferior.

Reversible.

Embalaje de alta seguridad.

Certificado de conformidad Europea.

Brazo de sujeción adaptable.

Manhattan in-out

Walk in

Negro

1 puerta + 1 fijo

- Tratamiento antical Fast Clean.
- Reversible.
- Cristal templado de 8 mm transparente.
- Embalaje de alta seguridad.
- Altura 200 cm.
- Certificado de conformidad Europea.
- Sin perfilera inferior.
- Brazo de sujeción adaptable.

100 cm

REF. A-12N A-22N
2

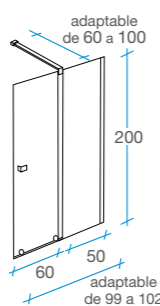

110 cm

REF. A-13N A-22N
2

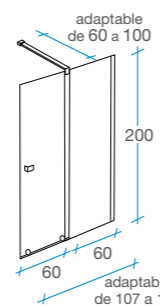

115 cm

REF. A-13N A-25N
2

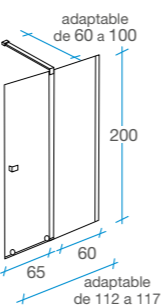

120 cm

REF. A-14N A-22N
2

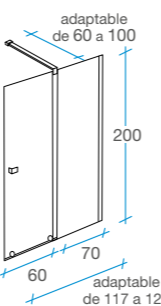

125 cm

REF. A-14N A-25N
2

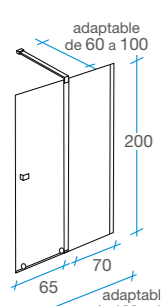

130 cm

REF. A-14N A-26N
2

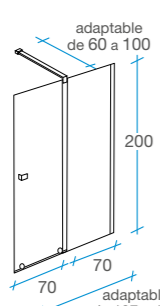

135 cm

REF. A-14N A-26N
2

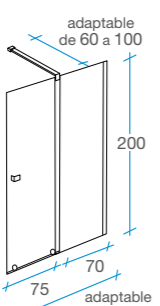

140 cm

REF. A-15N A-23N
2

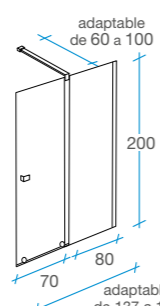

145 cm

REF. A-15N A-26N
2

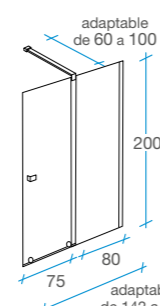

150 cm

REF. A-15N A-23N
2

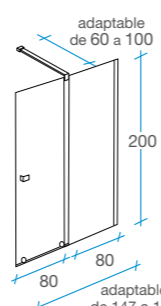

155 cm

REF. A-16N A-26N
2

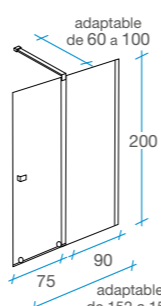

160 cm

REF. A-16N A-24N
2

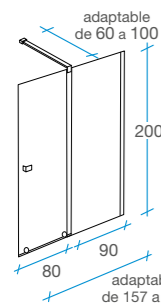

165 cm

REF. A-17N A-24N
2

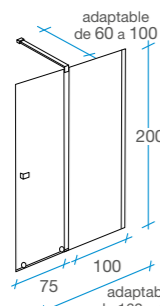

170 cm

REF. A-17N A-24N
2

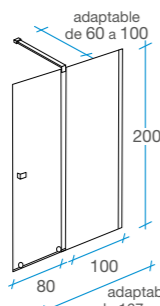

175 cm

REF. A-18N A-26N
2

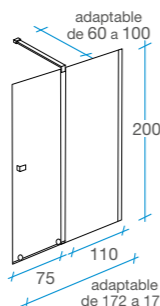

180 cm

REF. A-18N A-26N
2

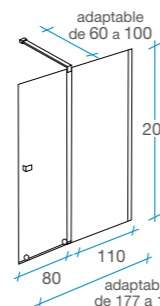

185 cm

REF. A-19N A-26N
2

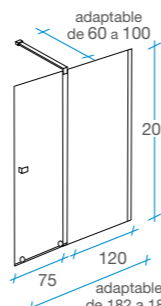

190 cm

REF. A-19N A-24N
2

